



# KUBO 2

last update 25/07/2016

TER1016

**Kubo 2** : code 147. EC . \_\_

2x max.50W - GU10/QPAR16 - 230V~ - CE - IP20 -  -  - 

TerZoLight

BEL LIGHTING sprl  
Avenue Ernest Solvay 42  
B-1480 Saintes (Tubize)  
Belgium  
Phone: +32(0)2 3552428  
Fax: +32(0)2 3550396  
e-mail: info@bel-lighting.com  
www.bel-lighting.com

code: C147.EC.\_\_

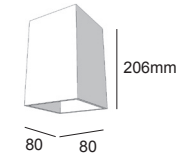

## INSTALLATION INSTRUCTIONS - PART A

1. FIT THE WALL FIXATION
2. MAKE THE ELECTRICAL CONNECTION
3. PLACE THE LUMINARY
4. SWITCH ON

### ACCESSORY SET (I)

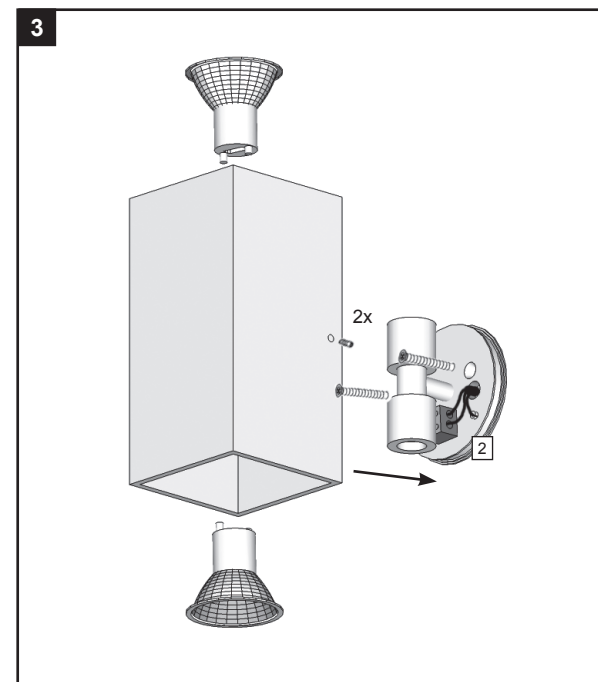
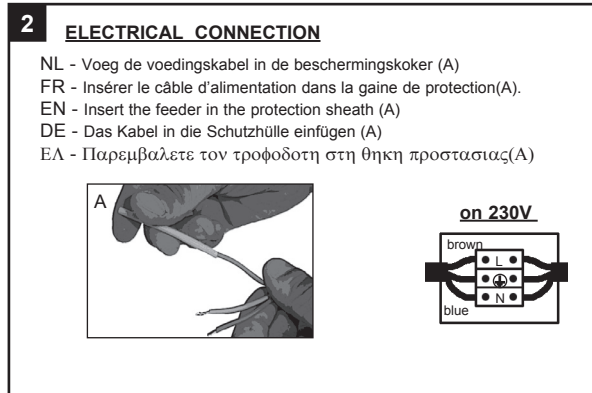
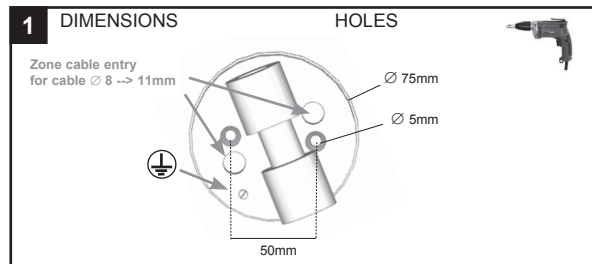

**PART**

**A**

Lees de algemene gebruiksvoorwaarden : PART B  
Lire attentivement les conditions générales d'utilisation: PART B  
Read attentively the general instructions: PART B  
Lesen Sie die allgemeinen Gebrauchsanweisungen: PART B  
Διαβάστε τις γενικές οδηγίες : PART B

WAARSCHUWING  
AVERTISSEMENT  
WARNING  
WARNUNG  
ΠΡΟΣΟΧΗ